

FFH

POSITION LIMIT SWITCH

Technical data

Standards	IEC/EN 60947/3
Case	self extinguishing housing V0 UL94
Protection class	IP67 double insulation
IEC/EN 60529	
Cable entry	M16 / M20
Operating temperature	-25 ... +55°C
Storage temperature	-30 ... +70°C
Notes	- 200/300 mm adjustable aluminium rods with "0" indicator - reinforced mechanical stop

Limit switches FFH series are in conformity with the following standards or other normative documents:

EN 60947-1	2007/A1 : 2011/A2 : 2014
EN 60947-3	2009/A1 : 2012/A2 : 2015
EN 60204-1	2006/A1 : 2009
EN 60529	1991/A1 : 2000/A2 : 2013
EN 50581	2012
IEC 63000	2016

and therefore follow the provision of the Directives:

2014/35/UE
2011/65/UE
2015/863/UE

Markings



Cam switch technical data

Product ID	P016 Giovenzana line		
Rated enclosed thermal current	I _{the}	16 A	
Rated insulation voltage	U _i	690 V	
Connections	terminals gauge	EN60947-1	A3
	terminals screw	M3.5	
	tightening torque	EN60947-1 UL508	0.8 N×m / 7.2 lb×in 7.5 lb×in / 0.85 N×m
Connectable section	flexible cable	1 × 0.75 ... 4 mm ² or 2 × 0.75 ... 2.5 mm ² 18 ... 10 AWG	
	rigid cable	1 × 0.75 ... 4 mm ² or 2 × 0.75 ... 2.5 mm ² 18 ... 10 AWG	
Contacts	double breaking		

Overall dimensions

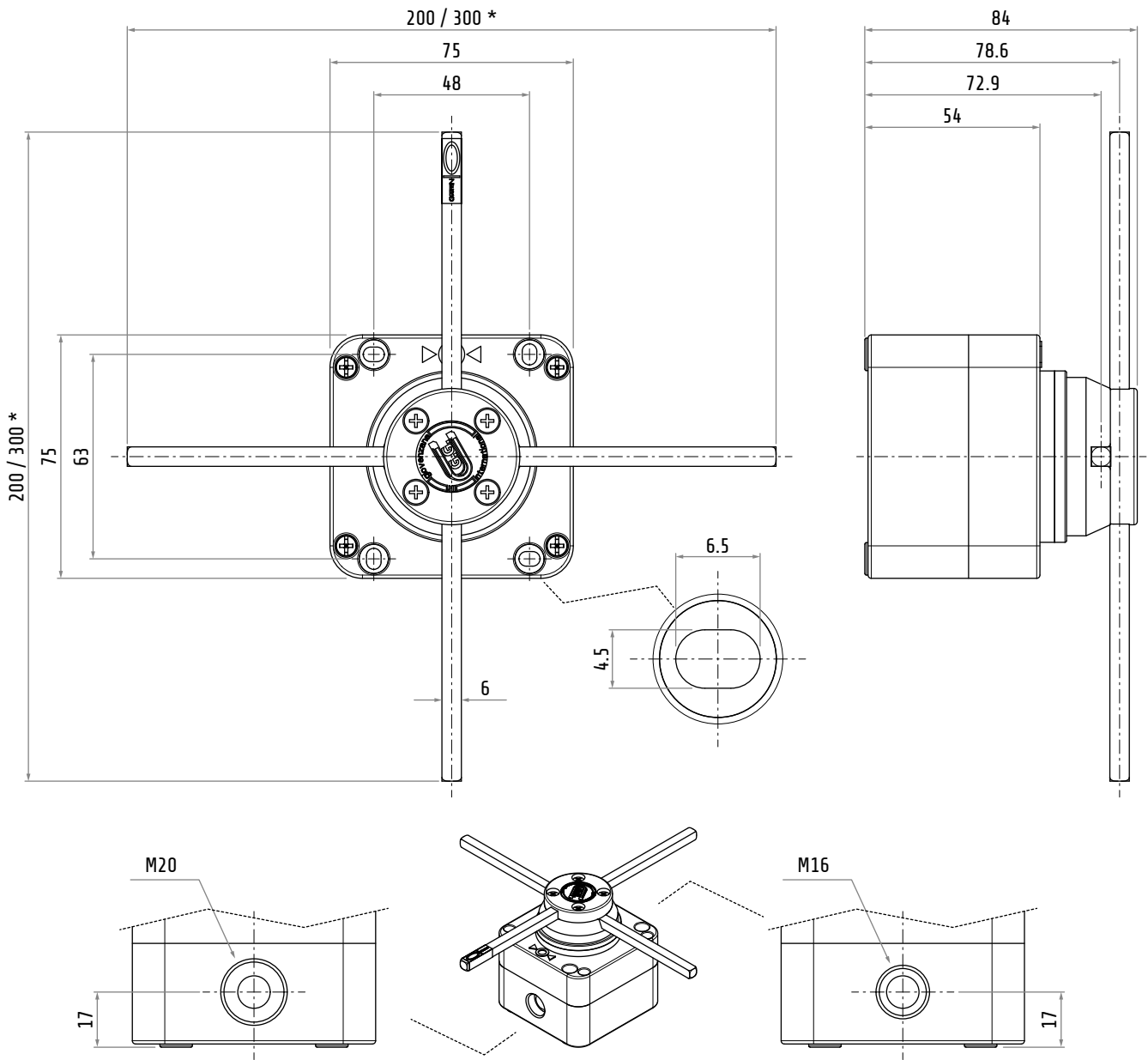

Dimensions in mm / illustrations NOT in scale

* The length of the rods varies according to the model

VERSIONS

Cam switch operation

FFH001

- Single speed
- 3 positions
- With mechanical interlock ●

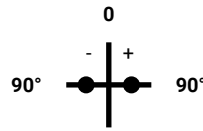

1	3-4		×	×
	1-2	×	×	
		-90°	0	+90°

FFH002

- Single speed
- 3 positions
- With mechanical interlock ●

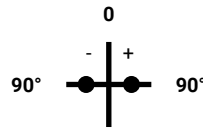

2	7-8		×	×
	5-6	×	×	
1	3-4		×	×
	1-2	×	×	
		-90°	0	+90°

FFH003

- Single speed
- 4 positions rotary
- Without mechanical interlock

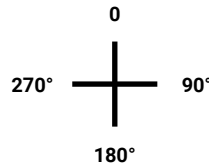

1	3-4	×		×	
	1-2	×		×	
		0	90°	180°	270°

FFH004

- Single speed
- 4 positions rotary
- Without mechanical interlock

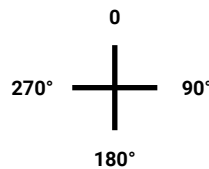

2	5-6	×	×		×
	1-2	×			
		0	90°	180°	270°

FFH005

- Single speed
- 4 positions rotary
- Without mechanical interlock

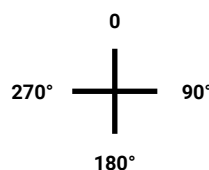

2	5-6	×			×
	1-2	×	×		
		0	90°	180°	270°

FFH006

- Double speed
- 4 positions
- With mechanical interlock ●

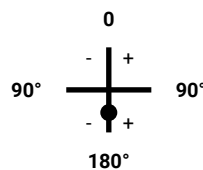

2	7-8	×	×	×	×	
	5-6	×	×	×		
1	3-4			×	×	×
	1-2		×	×	×	×
		-180°	-90°	0	+90°	+180°

OTHER VERSIONS AVAILABLE ON REQUEST